

Article number: 20193B40V40602BL
 Description: E+G T-angle clamp
 GN 193-B40-V40-60-2-BL

Measures

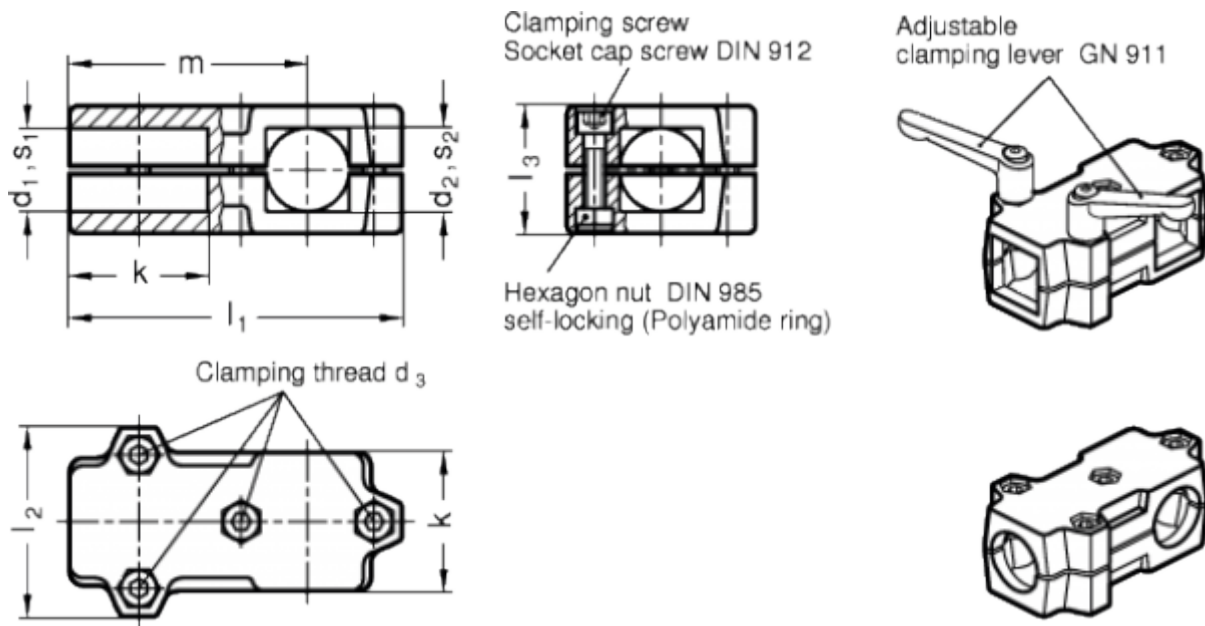

Accessories = GN 911-M10-55	m	= -
d1 = 40	s1	= -
d2 = -	s2	= 40
d3 = M8	Weight in (g)	= 638
k = 60		
l1 = 141		
l2 = 79		
l3 = 59		